



# SYNCFO 4 in 1 Coffee Analyzer

## Quick Activation Guide

Dear client, thank you for purchasing SYNCFO Coffee Analyzer. When you receive your analyzer, please follow the Quick Activation Guide below to make sure the analyzer is working in the proper way.

### A Unit item lists

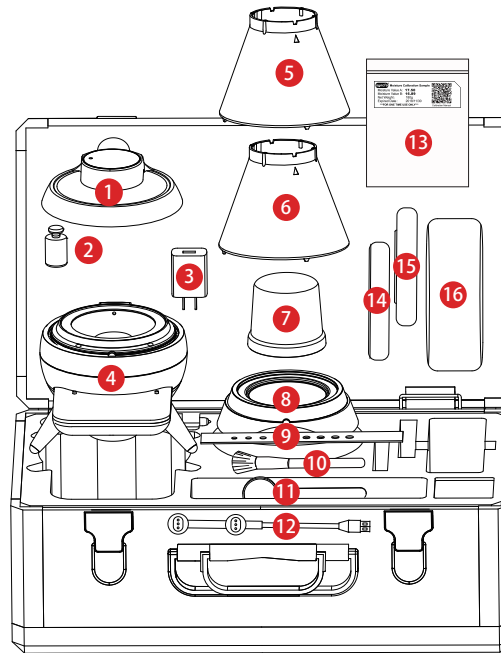

#### Full Unit Packing Display:

- 1. Top unit
- 2. Calibration weight
- 3. Charger
- 4. Bottom Unit
- 5. Cyclone cover
- 6. Funnel
- 7. Measurement cup
- 8. Base unit
- 9. Ruler
- 10. Brush
- 11. Spoon
- 12. Dual-headed charging cable
- 13. Moisture calibration sample
- 14. Powder plate
- 15. Bean plate
- 16. Color calibration plate (with gloves)

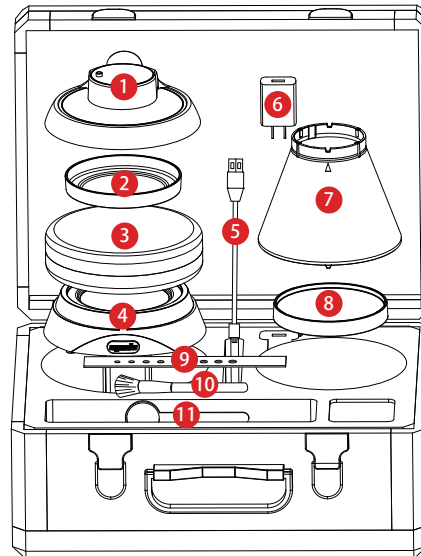

#### Single Unit Packing Display:

- 1. Top unit
- 2. Bean plate
- 3. Color calibration plate (with gloves)
- 4. Base unit
- 5. USB charging cable
- 6. Charger
- 7. Cyclone cover
- 8. Powder plate
- 9. Ruler
- 10. Brush
- 11. Spoon

### B Remove the Protection Pads of Analyzer

**CAUTION : Remain 3 plastic pads on bean chamber might affect the testing result!**

Step 1: Please remove 3 tapes from the top of bottom units. (Picture 1)

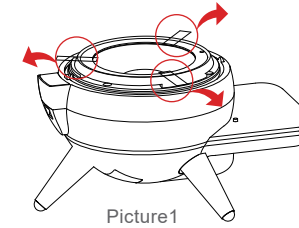

Picture1

Step 2: Please remove 3 plastic pads from the bottom units. (Picture 2)

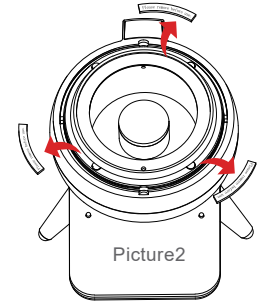

Picture2

### C To Activate the Top & Bottom Unit

● Switch on the power safety protection switch:  
Please check the bottom of both units and follow the red arrow as the pictures shown below. Push the black power safety protection switches **TWICE** to the "on" position to activate analyzer

1. Top unit activation

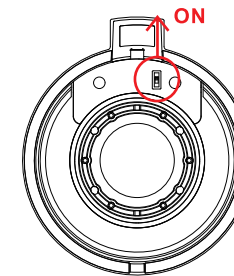

2. Bottom unit activation

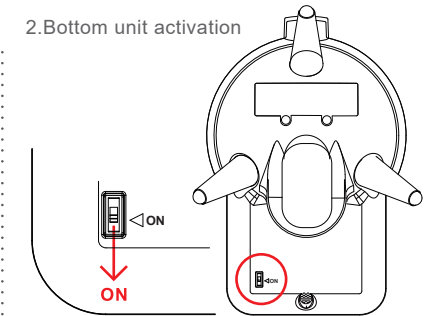

● Combination of top unit and cyclone cover:

1. Please match the arrows on top unit and cyclone cover

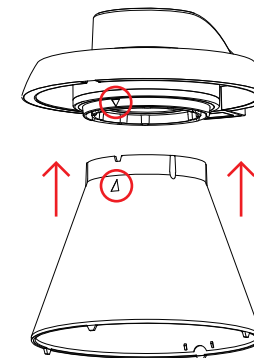

2. Follow the diagram to complete assembly

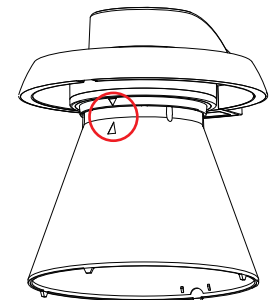

## D Three Modes of Configuration

### Top unit

(Color score analyzing)

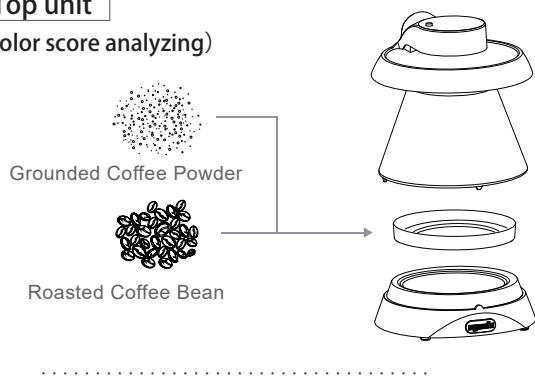

### Bottom unit

(Moisture, density, temperature analyzing)

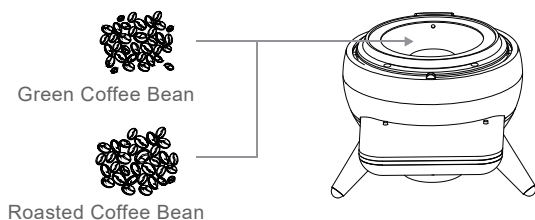

Remark: PRO version can test dry cherry & parchment.

### Full unit

(Moisture, density, temperature, color score analyzing)

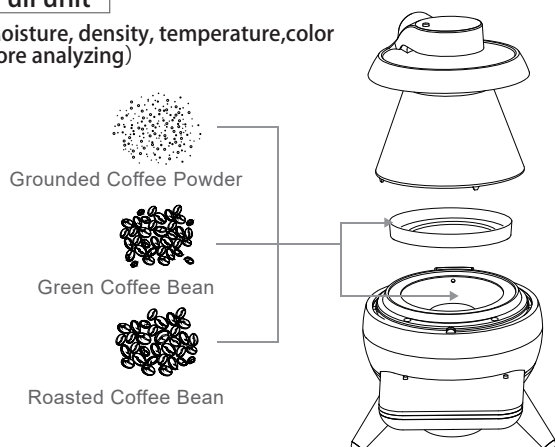

Remark: PRO version can test dry cherry & parchment.

## E Bottom Unit Function Explanation

### 1. Control Panel

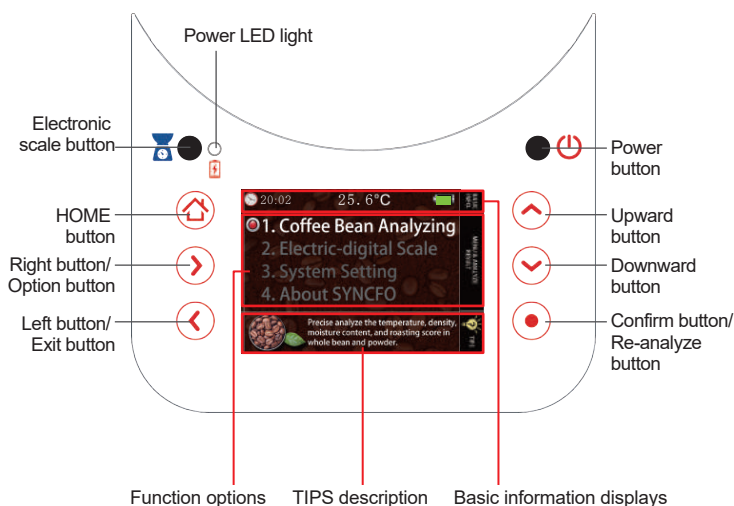

### 2. Menu 1-Coffee Bean Analyzing (a.) Menu 1-1 ~ 1-3

Choose the options shown on the screen to analyze the testing object, including: green beans, roasted beans or grounded coffee. The result will show on the screen in 3 seconds. (During analyzing, press HOME button or left button to cancel the analyzing at any time.)

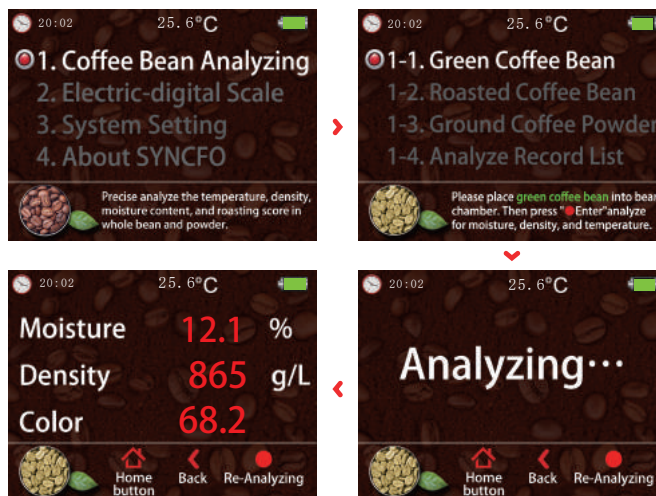

## F Top Unit Function Explanation

### 1. Control Panel

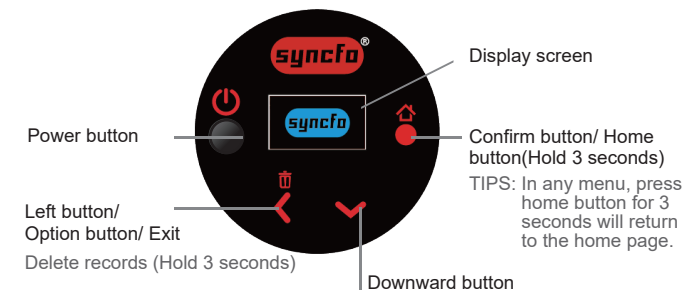

### 2. Menu 1-ANALYZES

Choose the options shown on the screen to analyze the testing object, including: green beans, roasted beans or grounded coffee. The result will show on the screen in 3 seconds. (During analyzing, press HOME button or left button to cancel the analyzing at any time.)

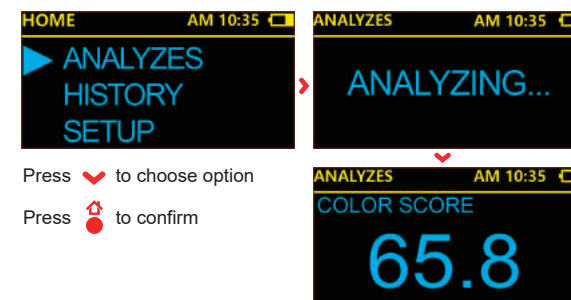

Press to choose option

Press to confirm

### G Battery Charging

To charge the battery, please put the top unit on the bottom unit into a sphere like. Use the dual headed magnetic charger and connect it to the charging port at the back of both units. Note: Make sure the power safety protection switches are in "on" position for both units during charging.

